

1300 PROFILE

1000 Series

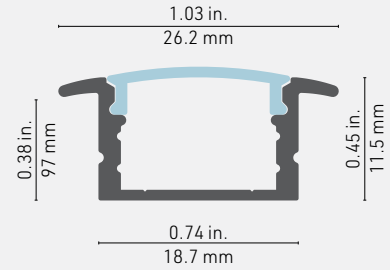

Cross-section dimensions:



A COMPACT AND RECESSED PROFILE

Here is a **compact and recessed** profile allowing you to make the LED light source invisible. The edges on each side of this extrusion allow for a recessed installation, while having understated style with its discreet and neat appearance.

FEATURES

- Designed to give a uniform light without hot spots with an opal or prime lens.
- The edge allows recessed installation. To be installed in a 19mm (3/4-inch) groove.
- Custom length by sections of 2 to 240 inches (6m).
- Application guide for 10mm (3/8-inch) LED engine or less.
- Made of ALCOA 6063-T5 aluminum alloy increasing heat dissipation.
- Its use increases the lifetime of your LED engine.
- Compatible with multiple installation accessories.
- Designed to meet North American woodworking standards.

OPTIONS



LED ENGINE COMPATIBILITY









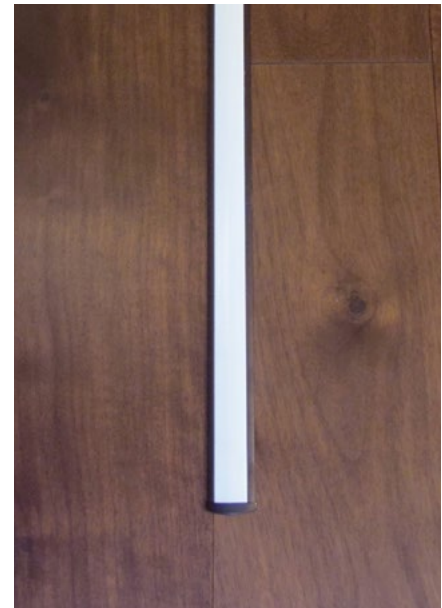
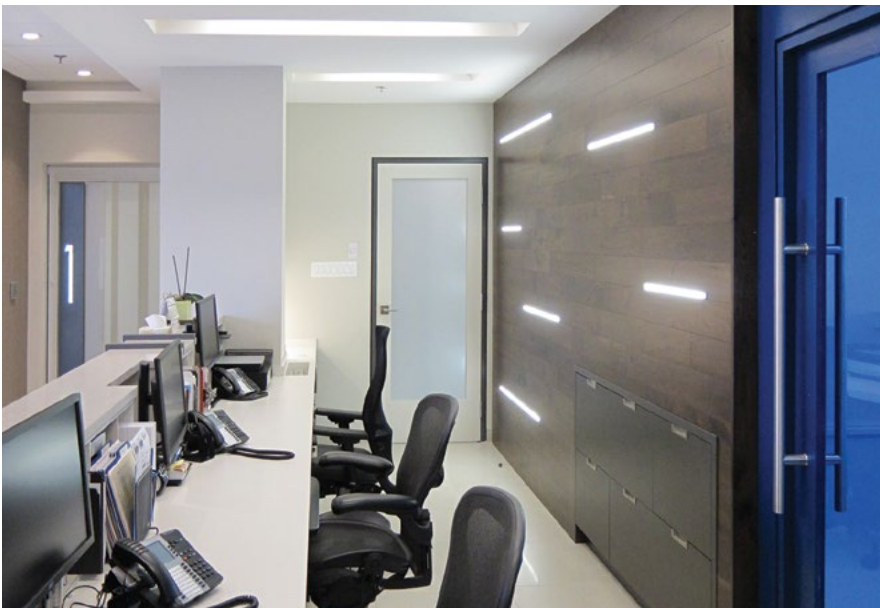

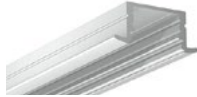
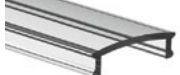

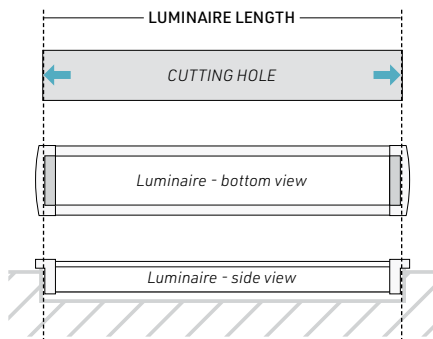

IP22: Compatible with LED engines up to **14mm** wide.

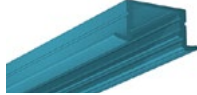
IP68: Compatible with LED engines up to **10mm** wide.

LINEAR WEIGHT

0.115 lbs/ft, 0.171 kg/m (without lens)



PROFILE	LENSES	MOUNTING HARDWARE	MOTION SENSORS*	LENGTH
 <p>1300 - 1300 Profile, alu</p>	 <p>CL - Clear lens</p>	 <p>FL - Flat bracket</p>	 <p>SEN1 - 30 sec. Embedded</p>	<p>Custom length by sections of 2 to 240 inches (6m).</p> <p>*NOTE: Follow this diagram to calculate the correct length</p> 
 <p>1301 - 1300 Profile, black</p>	 <p>SP - Spread lens</p>	 <p>3M - Mounting tape, double face</p>	 <p>SEN3 - 4 min. Embedded</p>	
 <p>130X - 1300 Profile, custom color</p> <p>IMPORTANT: Give RAL color No See Appendix 1 on page 158</p>	 <p>OX - Optiflex lens</p>	 <p>NO - No mounting hardware</p>	 <p>SEN5 - Intergrated proximity hand motion sensor</p>	
RAL NUMBER	 <p>OP - Opat lens</p>	 <p>NO - No sensor</p>	<p>*NOTES</p> <p>All motion sensors: Max 36W/12V or 72W/24V</p>	
	 <p>PR - Prime lens</p>	 <p>NO - No lens</p>		
PROFILE	LENS	MOUNTING HARDWARE	MOTION SENSOR	LENGTH

COLOR TEMPERATURE	LUMEN PACKAGE*	LEAD IN/OUT	USAGE	POWER SUPPLY/CONTROL	*NOTES
<p>24 - 2400K</p> <p>27 - 2700K</p> <p>30 - 3000K</p> <p>35 - 3500K</p> <p>42 - 4200K</p> <p>53 - 5300K (LHP only)</p> <p>62 - 6200K (LP only)</p> <p>WD1 - WarmDim 14W</p> <p>WD2 - WarmDim 17W</p> <p>TW1 - Tunable White 11W</p> <p>TW2 - Tunable White 19W</p> <p>RGB1 - RGB 14W</p> <p>RGB2 - RGB 19W</p> <p>RGBW1 - 3000K</p> <p>RGBW2 - 3000K 4in1</p>	<p>LP0 - 128 LM / 1.5W FT / 90+CRI</p> <p>LP1 - 160 LM / 1.5W FT / 90+CRI</p> <p>LP2 - 255 LM / 3.0W FT / 90+CRI</p> <p>LP3 - 308 LM / 4.5W FT / 90+CRI</p> <p>LP4 - 400 LM / 5.8W FT / 90+CRI</p> <p>LHP - 700 LM / 7.0W FT / 95+CRI</p> <p>Note: Not applicable for Warmdim Tunable White & RGB color temperatures</p>	<p>HW3 - Hardwire 3 FT</p> <p>HW6 - Hardwire 6 FT</p> <p>HW9 - Hardwire 9 FT</p> <p>HWX - Hardwire custom FT</p> <p>DC3 - DC plug 3 FT</p> <p>DC6 - DC plug 6 FT</p> <p>DC9 - DC plug 9 FT</p> <p>DCX - DC plug custom FT</p> <p>NO - No lead</p>	<p>I - IP22 indoor dry location</p> <p>O - IP68 wet/damp location</p> <p>Note: IP68 not available with motion sensor option.</p> <p>LHP, WD2 and RGBW options are only available in IP22.</p>	<p>A - Non-dimming</p> <p>B - ELV dimming 120V AC</p> <p>C - ELV dimming 120/277 VAC**</p> <p>D - 0/10V dimming 120/277 VAC</p> <p>E - Non-dimming DC plug in</p> <p>F - DMX</p> <p>G - Lutron - HI-LUME PREMIER 0,1% Eco System 24V/96W</p> <p>I - Casambi CBU-A2D-0/10V-DALI-Bluetooth 100/277 VAC</p> <p>J - Casambi CBU-PWM4-4CH-Bluetooth 100/277 VAC</p> <p>K - Casambi CBU-TED-CV-Trail edge dim-Bluetooth 120 VAC</p> <p>NO - No driver</p>	<p>*The light output is provided in lumens per foot, for a CCT of 4200K and a clear lens. Please refer to the optics page for CCT and translucency conversion factors.</p> <p>** Only available in 96W - 24V Driver</p> <div style="border: 1px solid black; padding: 5px; display: inline-block;"> <p>TITLE</p> <p>24</p> <p>COMPONENTS</p> </div>

COLOR TEMPERATURE CCT LUMEN PACKAGE LEAD IN LEAD OUT USAGE POWER SUPPLY/CONTROL

ASSEMBLY DIMENSION / DIMENSION D'ASSEMBLAGE

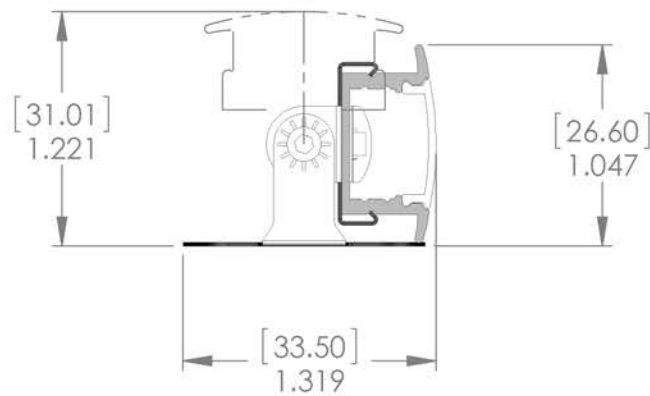
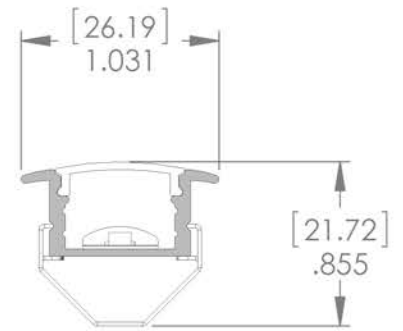
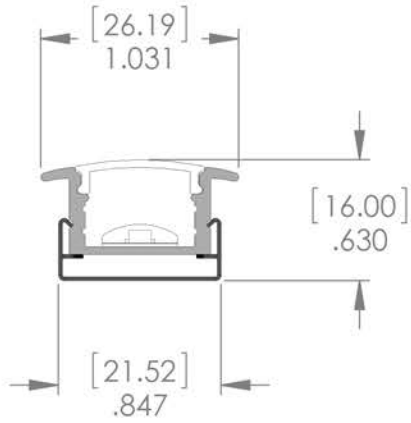

mm
inches/pouces

NOTES

