

3100 PROFILE

3000 Series

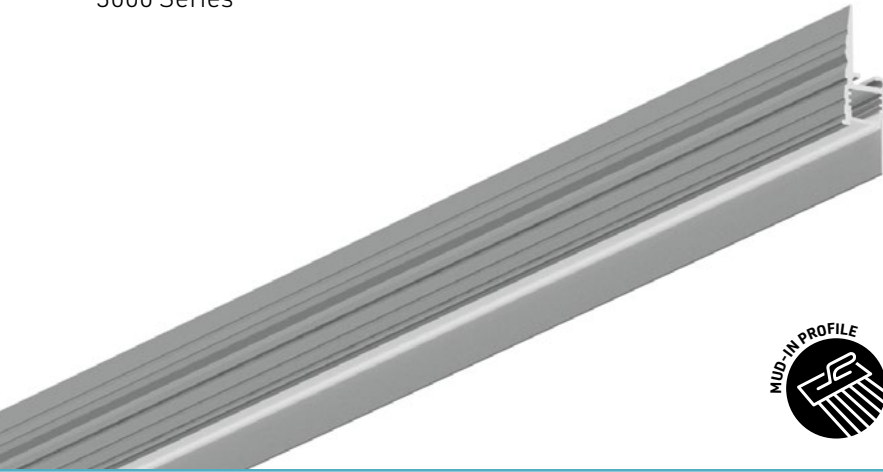

Cross-section dimensions:

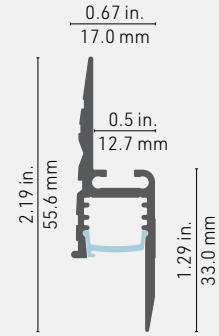

REDEFINES CONTOUR LIGHTING!

Ideal for night lighting and dramatically enhancing the perimeter of a room, the new 3100 aluminum profile is recessed and provides uniform contour lighting, downward, at 90°. It fits perfectly with standard gypsum panels for a seamless finish. This wall application meets aesthetic and safety needs in areas with low levels or poor lighting. Perfect for lighting a corridor in a residence or a hotel!

FEATURES

- Designed to be recessed and provide uniform contour lighting, downward, at 90 degrees. Indoor use for residential or commercial applications.
- Direct adjustment with standard 1/2 inch gypsum panels and with 5/8 inch gypsum panels.
- Impeccable finish thanks to the grooves that allow the profile to be leveled to the plasterboard using joint compound.
- Available in 96 inch (2.43 m) lengths for easy and accurate on-site installation.
- Equipped with a Prime lens for uniform illumination without light dots and optimal light diffusion.
- 8 mm LED light source: 4.8 W, 9.6 W, and 14.5 W, with 5 color temperatures (2400 K to 4200 K), also available in 10 mm width in 14.4 W-RGB.
- Designed to meet North American woodworking standards.

OPTIONS



LED ENGINE COMPATIBILITY







Compatible with LED engines up to **10mm** wide.

LINEAR WEIGHT













0.330lbs/ft, 0.491kg/m (without lens)



PROFILE	LENGTH	LENSES
 <p>3100 QTY - Profile</p>	<p>Available in straight section of 8 feet (96 inches/2.4 m). *Cut on site</p>	 <p>PR - Prime lens</p>  <p>SIL - SiLens</p>
QUANTITY	X 96 INCHES LENGTH	LENS

ENDCAPS		JOINERS			ACCESSORIES
 <p>3150 left endcap</p>	 <p>3150 right endcap</p>	 <p>Type A straight joiner</p>	 <p>Type A horz. 45°/135° joiner</p>	 <p>Type A horz. 90° joiner</p>	 <p>Drywall small head screw (x100)</p>
QUANTITY	QUANTITY	QUANTITY	QUANTITY	QUANTITY	QUANTITY

LED engine will be assembled on site. See Appendix 3 on page 159 to see how to calculate total ordering length.

COLOR TEMPERATURE	LUMEN PACKAGE*	LEAD IN/OUT	USAGE	POWER SUPPLY/CONTROL	LENGTH
<ul style="list-style-type: none">  24 - 2400K  27 - 2700K  30 - 3000K  35 - 3500K  42 - 4200K  53 - 5300K (LHP only)  62 - 6200K (LP only)  WD1 - WarmDim 14W  TW1 - Tunable White 11W  TW2 - Tunable White 19W  RGB1 - RGB 14W  RGB2 - RGB 19W 	<ul style="list-style-type: none"> LP0 - 128 LM / 1.5W FT / 90+CRI LP1 - 160 LM / 1.5W FT / 90+CRI LP2 - 255 LM / 3.0W FT / 90+CRI LP3 - 308 LM / 4.5W FT / 90+CRI LP4 - 400 LM / 5.8W FT / 90+CRI LHP - 700 LM / 7.0W FT / 95+CRI <p>Note: Not applicable for Warmdim, Tunable White and RGB color temperatures</p>	<ul style="list-style-type: none"> HW3 - Hardwire 3 FT HW6 - Hardwire 6 FT HW9 - Hardwire 9 FT HWX - Hardwire custom FT DC3 - DC plug 3 FT DC6 - DC plug 6 FT DC9 - DC plug 9 FT DCX - DC plug custom FT NO - No lead 	<ul style="list-style-type: none"> I - IP22 indoor dry location 	<ul style="list-style-type: none"> A - Non-dimming B - ELV dimming 120V AC C - ELV dimming 120/277 VAC** D - 0/10V dimming 120/277 VAC E - Non-dimming DC plug in F - DMX G - Lutron - HI-LUME PREMIER 0,1% Eco System 24V/96W I - Casambi CBU-A2D-0/10V-DALI-Bluetooth 100/277 VAC J - Casambi CBU-PWM4-4CH-Bluetooth 100/277 VAC K - Casambi CBU-TED-CV-Trail edge dim-Bluetooth 120 VAC NO - No driver 	<p>Total length of LED engine in inches - See Appendix 3 on how to calculate length.</p>
COLOR TEMPERATURE CCT	LUMEN PACKAGE	LEAD IN LEAD OUT	USAGE	POWER SUPPLY/CONTROL	LED ENGINE LENGTH

*NOTE: The light output is provided in lumens per foot, for a CCT of 4200K and a clear lens. Please refer to the optics page for CCT and translucency conversion factors. ** Only available in 96W - 24V Driver