

7900 (7920) Profile

7900 (LM22260)



7000 Series

Cross-section dimensions:

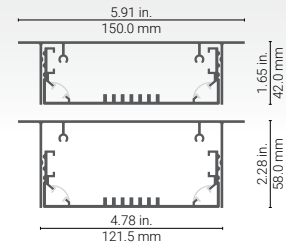

Here is probably the **most customizable light canopy** on the market! The 7900 accepts cover extrusions to house a range of **LED drivers internally**⁽¹⁾, and includes wire covers for easy cable management. It is available as either a 10" long kit, or in the **length of your choice**, up to 20 feet. You can have custom CNC-machined junction box openings at your choice!

(1) The driver's maximum acceptable height is 1-1/4" (33 mm) with the 7920 cover, and 1-7/8" (49mm) with the 7930 cover.

Features

- Custom length by sections of 6 to 240 inches (6m) with the use of the 7920 or 7930 aluminum covers, or in a 10" long kit using the 7950 steel cover (LM22840-50).
- Linear lengths over 20 feet as well as more complex shapes with corners can be accomplished with the use of joiner accessories.
- The base profile has a CNC-drilled holes for direct fit onto electrical junction boxes; these can be ordered in custom and multiple positions.
- Will accommodate an extensive range of LED drivers, up to 1-1/4" (33 mm) high with the 7920 cover, and 1-7/8" (49mm) high with the 7930 cover. The driver is screwed onto the rail at the base of the profile.
- The profile has two internal channels with wire covers for easy cable management.
- Made of ALCOA 6063-T5 aluminum alloy increasing heat dissipation.

Options



Linear weight

1.882 lbs/ft, 2.801 kg/m (with 7920 cover profile), 1.984 lbs/ft, 2.952 kg/m (with 7930 cover profile)



With 7920 Cover

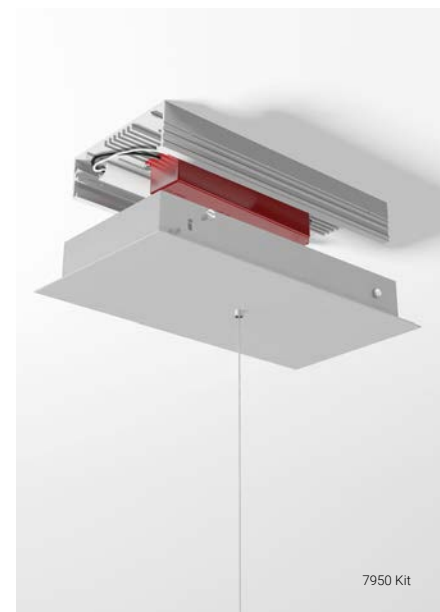









7950 Kit

7900 Profile

Components and accessories

7000 Series

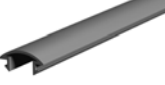
PROFILE	COVER	ENDCAPS	ACCESSORIES	LENGTH
 <p>7900 Base Profile 7900 (LM22260)</p>	 <p>7920 cover profile, 1.65"H Alu 7920 (LM22260-20)</p>	 <p>Endcap for 7920 profile, Alu 7905 (LM22260-25)</p>	 <p>Type B straight joiner 1325 (LM22335-01)</p>	<p>Custom length by sections of 6 to 240 inches (6m).</p>
	 <p>7930 cover profile, 2.28"H Alu 7930 (LM22260-30)</p>	 <p>Endcap for 7930 profile, Alu 7915 (LM22260-35)</p>	 <p>Type B vert. 90° joiner 1327 (LM22335-05)</p>	
			 <p>Type B vert. 45°/135° joiner 1330 (LM22335-06)</p>	
			 <p>Type B wire cover 8099 (LM22335-99)</p>	

7900	—	—	—	—
PROFILE	COVER	ENDCAPS	ACCESSORIES	LENGTH

OR

CANOPY KIT

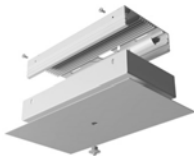

- 7950 10" Canopy Kit
- 7950 (LM22840-50) ALU
- 7961 (LM22840-61) WHITE
- 7962 (LM22840-62) BLACK
- 7963 (LM22840-63) CHROME
- 7964 (LM22840-64) BRUSHED NICKEL

CANOPY KIT

Notes

