

9820 - LuxLine 120V

9000 SERIES

LUMEN™
Truss



9820 LUXLINE PROFILE

9000 Series

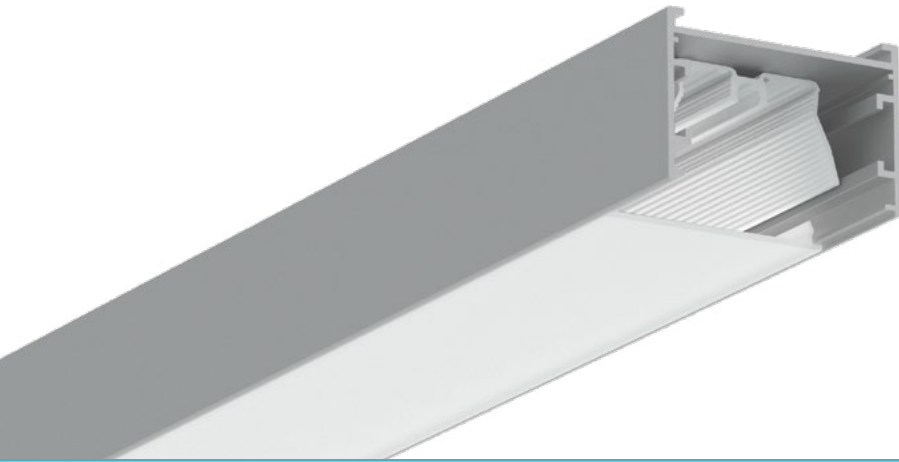

Cross-section dimensions:

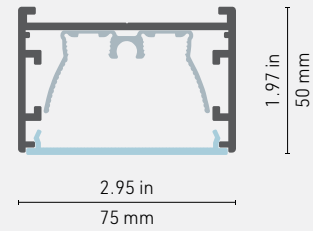

The 9820 is a 9000 series system designed for those looking for a minimalist effect. Its ultra-slim profile combined with our advanced LED technology make it a suitable solution to accentuate the geometric shapes of stairs, hallways, kitchen islands and much more.

FEATURES

- Dimensions: 3" wide and 2" high
- Luminaire casing available in section from 24" to 96" (max total of 164')
- Wide choice of color temperatures (2400K - 4000K)
- ELV/Triac dimmable
- Black and aluminum casing available
- Blind covers on both sides to eliminate dark spots
- No driver needed: 120V LuxLine light source, available up to 164 ft., for use with the HER reflector that holds it in place and provides maximum luminance
- Can be installed directly on a 2"x3" junction box
- Pre-made corners with joiners available for L, U and square/rectangular shapes to assemble on site
- Made of ALCOA 6063-T5 aluminum alloy for superior heat dissipation and increased LED light source life

OPTIONS



LED ENGINE COMPATIBILITY

Compatible with two runs of our LuxLine series of 120V LED engine tape.

LINEAR WEIGHT

0.793 lbs/ft, 1.18 kg/m

Figures provided for the aluminum profiles only – outer and inner enclosures, heatsink. The complete assembly, with LED light sources, reflectors, power supplies, endcaps, mounting hardware etc. will be greater, and will vary depending on product configuration.



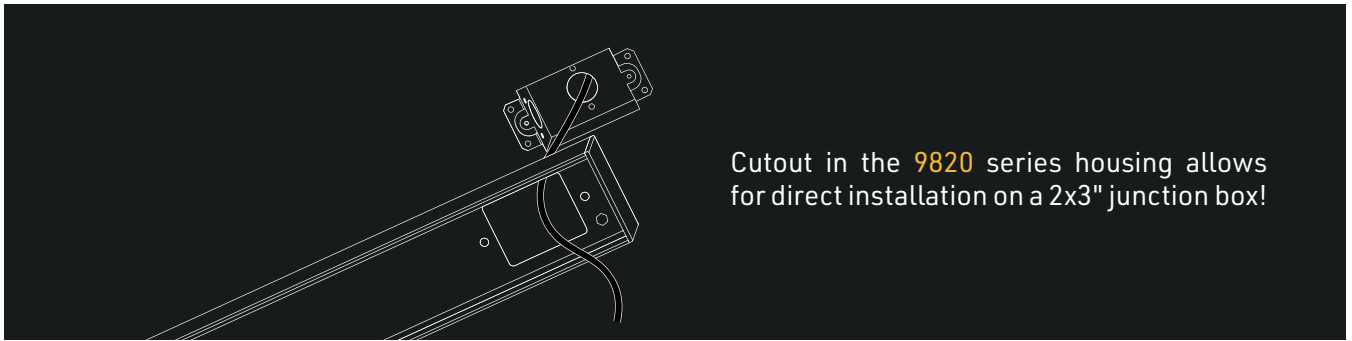

Cutout in the 9820 series housing allows for direct installation on a 2x3" junction box!

HIGH EFFICIENCY
REFLECTOR V2.1

HER² PRO

Significantly improves
luminous efficiency!

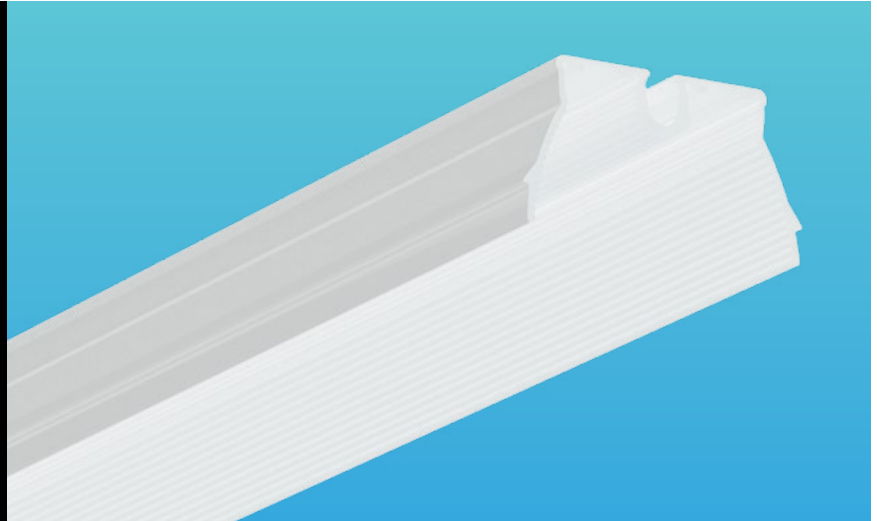





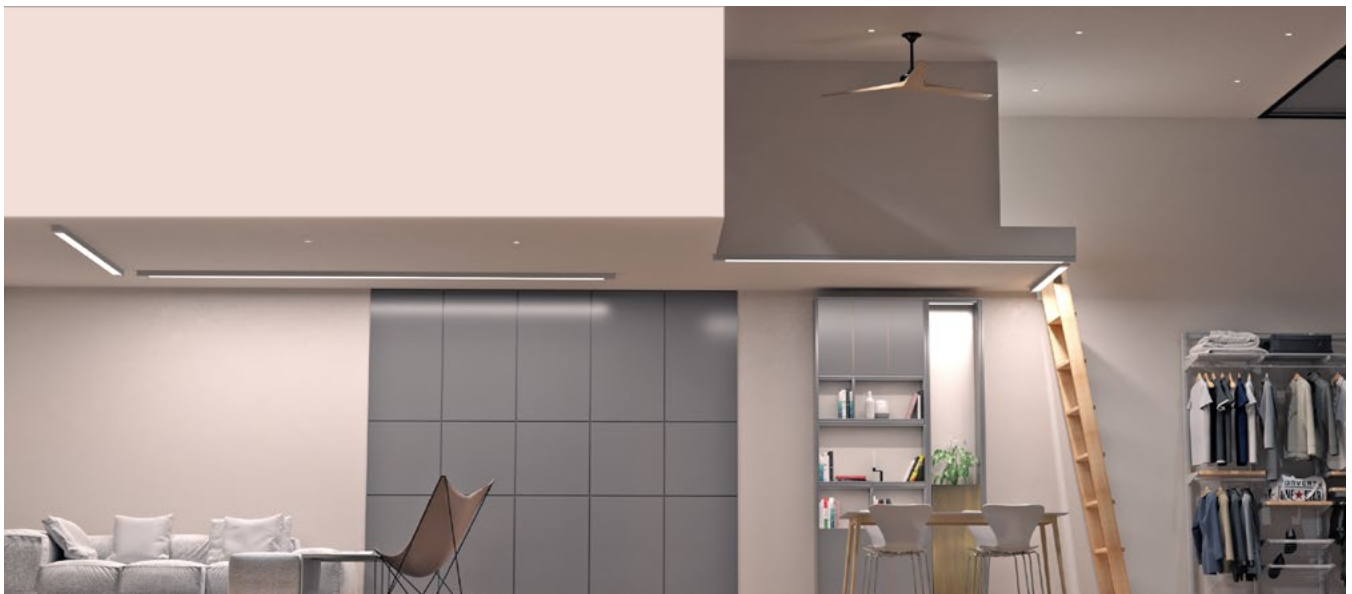
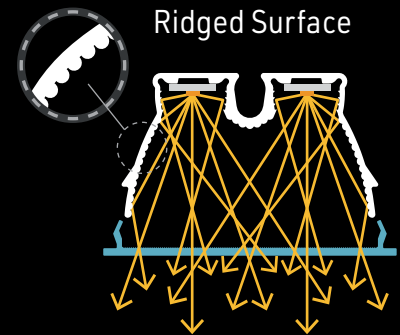







HER PRO - HIGH EFFICIENCY REFLECTOR V2.1





Achieve maximum luminous flux with the **HER Pro** (High Efficiency Reflector)! With its engineered design, this new reflector significantly improves luminous efficiency and provides lighting without loss of light. An ingenious idea that surpasses the use of white reflective paint to maximize lighting. The Pro version has been designed with our brand new Reflective Wave System – ridges on each side of the reflector – that helps provide even greater illumination!





PROFILE	MOUNTING TYPE	LENSES	REFLECTOR	BLIND COVERS	LENGTH
 <p>9820 - Alu</p>	 <p>S - Surface mount</p> <p>Note: Mounting hardware by others</p>	 <p>PR - Prime flat lens</p>	 <p>HER - High efficiency reflector</p>	 <p>BC2 - 2 covers of 4" on both sides</p>	<p>Custom length by sections of 24 to 192 inches.</p>
 <p>9821 - Black</p>					
 <p>982X - Custom color</p> <p>IMPORTANT: Give RAL color No See Appendix 1 on page 158</p>					

RAL NUMBER	PROFILE	MOUNTING TYPE	LENS	REFLECTOR	BLIND COVERS	LENGTH
		S	PR	HER	BC2	
						
	JS - Type C straight joiner	JH45 - Type C horiz. 45° joiner	JH90 - Type C horiz. 90° joiner	JV90 - Type C vert. 90° joiner	JV45 - Type C vert. 45° joiner	
	QUANTITY	QUANTITY	QUANTITY	QUANTITY	QUANTITY	

COLOR TEMPERATURE	LUMEN PACKAGE*	LEAD IN	USAGE	*NOTES
<ul style="list-style-type: none">  24 - 2400K  27 - 2700K  30 - 3000K  35 - 3500K  42 - 4000K 	2LUX - 700 LM / 8.0W FT / 90+CRI	HW - Hardwire 118"	2 - IP65 indoor	<p>The light output is provided in lumens per foot, for a CCT of 4200K and a clear lens. Please refer to the optics page for CCT and translucency conversion factors.</p> <div style="border: 1px solid black; padding: 2px; display: inline-block;"> <p>TITLE 24 www.lumentruss.com</p> </div>
	2LUX		IP65	
COLOR TEMPERATURE	LUMEN PACKAGE	LEAD IN		

LUXLINE FEATURES

- LumenTruss Driverless technology.
- Direct line voltage.
- Constant current IC providing uniform intensity over the entire run.
- Uses North American power plug with built-in fuse or hardwire.
- Order in lengths of 1 FT.
- 164 FT maximum run.
- Ultra high lumen output.
- Architectural grade.
- PVC coating (not recommended for direct sunlight).
- 3 year warranty.
- Life of 50,000 hours
- LED type: 3056
- WARNING: Do not cut AC plug.

LUXLINE FEATURES

Plug-in Connection Diagram

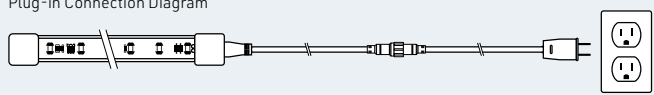

Hardwire Connection Diagram

With the NEW revolutionary hardwire connection with built-in fuse! Exclusive to LumenTruss.



NOTES

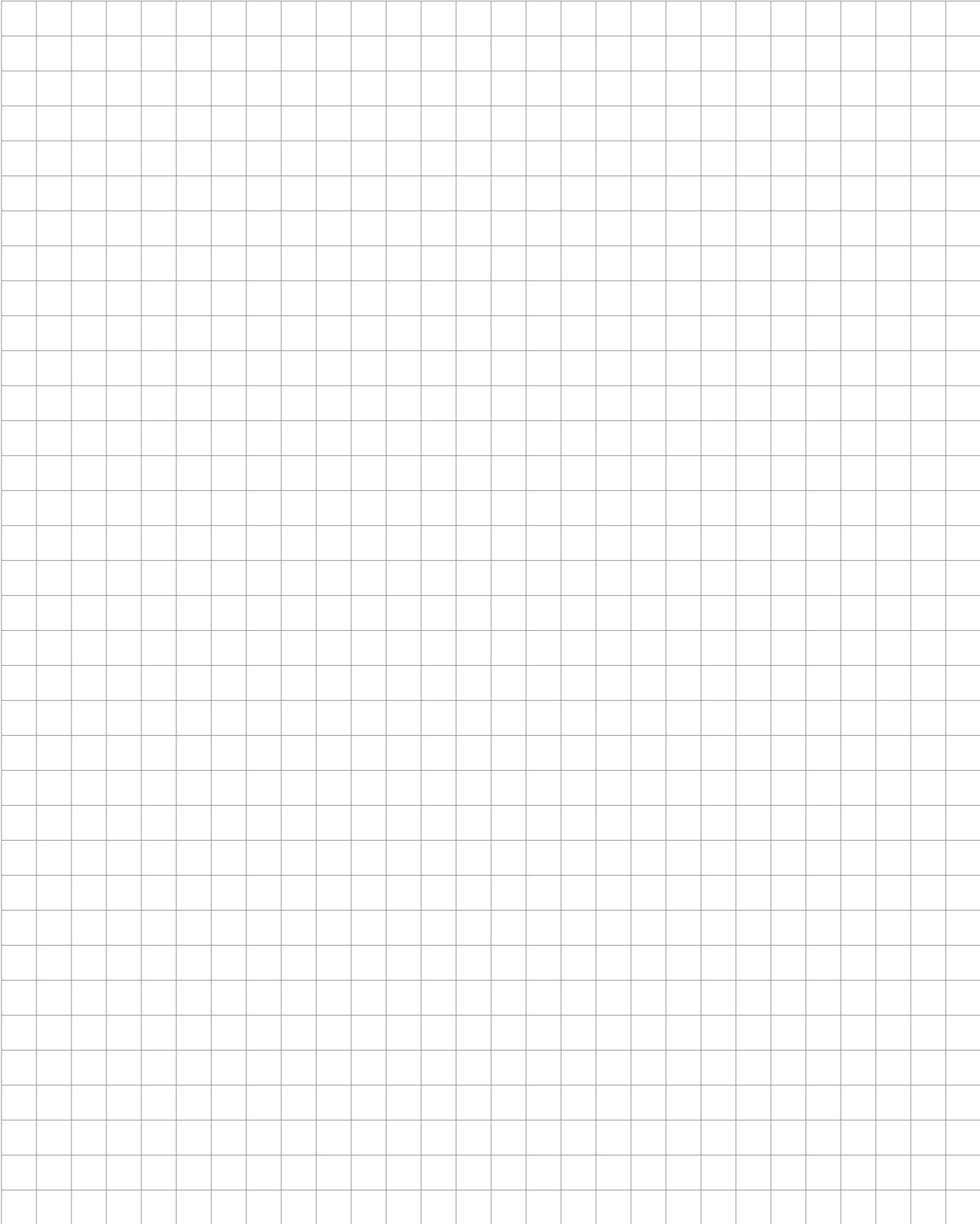

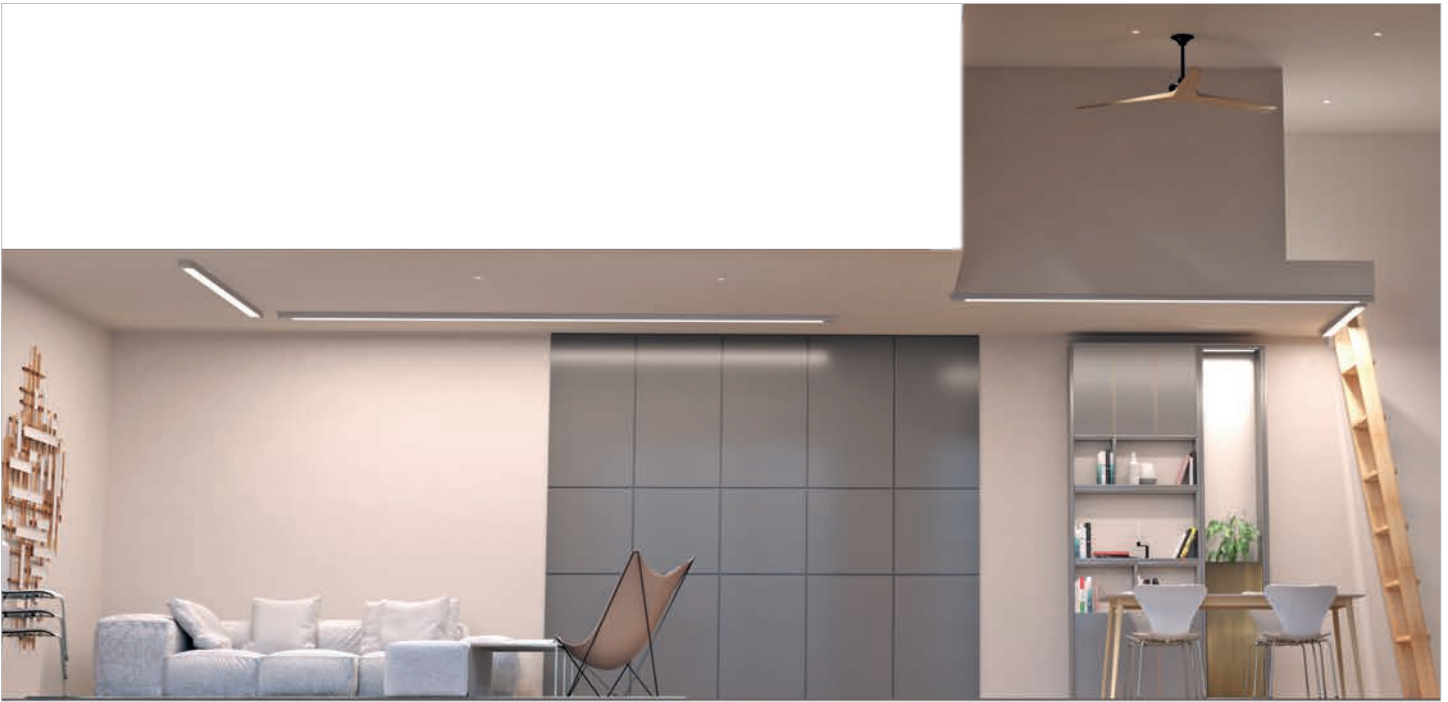

DESIGNED IN COLLABORATION WITH

Khorkhe Younes

Senior Lighting Designer

ZeroLUX Lighting Design is a collaborative studio that curates exceptional lighting experiences, that create spatial and emotional connections.

Our philosophy at zeroLUX Lighting Design emanates from a perspective that looks at the architecture of things as one entity. We understand all elements of architecture as interconnected and interdependent. It is through this holistic approach to lighting design wherein all elements of the space are integrated in many different ways.

CONTACT US

ADDRESS

9221 Edison
Montreal, Quebec,
H1J 1T4, Canada

FAX

1.514.903.0649

EMAIL

info@lumentruss.com

PHONE

1.855.384.3384

WEBSITE

www.lumentruss.com



MADE IN
NORTH AMERICA

LUMEN™
Truss